

Freedom

Boom Accessory Guide

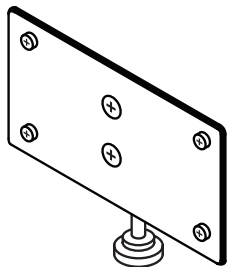

Rail Mounted Accessories



H8-200-37-1
Ophthalmoscope mount

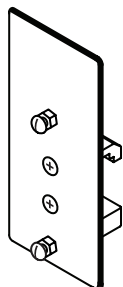

H8-200-98
Ophthalmoscope tip holder

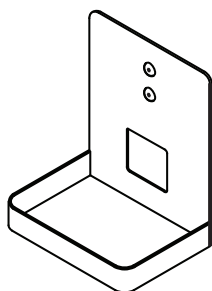

H8-201-00
Rail mounted tray for Welch Allen charger

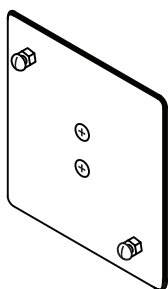

H8-200-97
Rail mounted bracket for Welch Allen Sure-Temp Thermometers

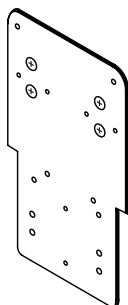

H8-200-42-1
Sharps holder

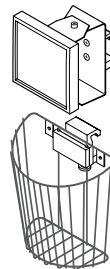

H8-200-95
Rail mounted Manometer with BP cuff basket

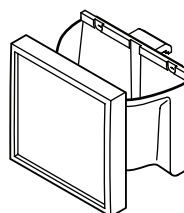

H8-200-95-1
BP Cuff basket only

H8-200-94
Rail mounted Manometer with built-in BP cuff holder

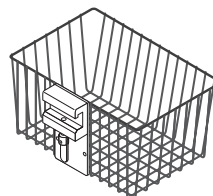

H8-200-09-A
Basket 8" x 12" x 6"

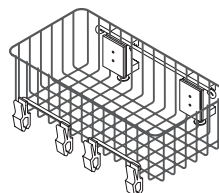

H8-200-31-1
Bottom mount basket 13" x 6 1/2" x 4" with 4 supply clips



H8-200-36-1
Chart holder

Rail Mounted Accessories

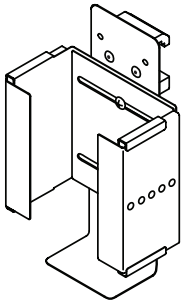

H8-200-41-1 Single
H8-200-41-3 Triple
Glove box holder

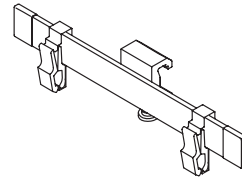

H8-200-46-1
Double supply clip

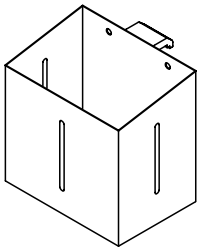

H8-200-88-1
Utility storage box

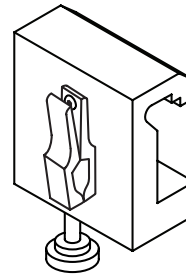

H8-200-46-2
Single supply clip

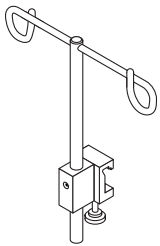

H8-200-83
IV Pole, 12" with holder

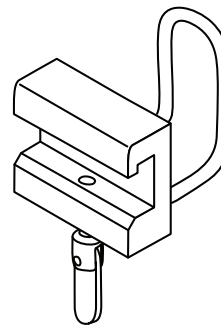

H8-200-10-A
Hook for headlight

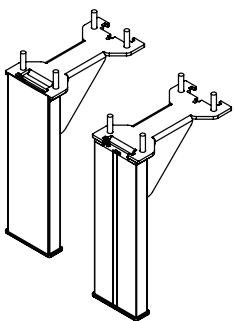

4A-EXF-12
12" Front Column Extension
4A-EXF-24
24" Front Column Extension
4A-EXB-12
12" Back Column Extension
4A-EXB-24
24" Back Column Extension

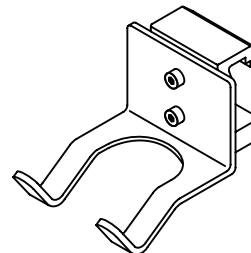

H8-200-43-1 Adult
H8-200-43-2 Pediatric
Resuscitation bag holder

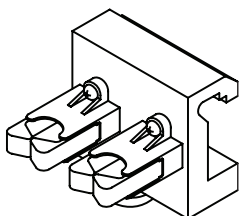

H8-200-45-1
Double tubing clip

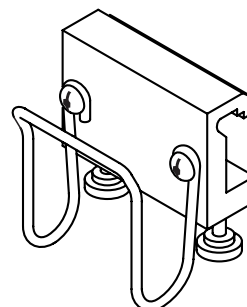

H8-200-92
4" Rail mounted cable holder

Rail Mounted Accessories

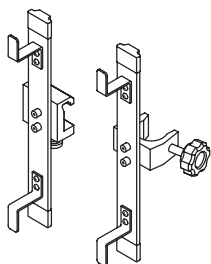

H8-200-38-1
Cord wrap rail mounted
H8-200-38-2
Cord wrap pole mounted

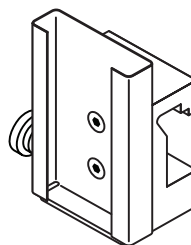

H8-200-07
Vacuum slide, rail mount

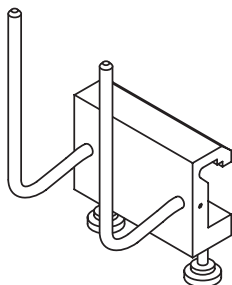

H8-200-32-1
Dual hook

Channel Mounted Accessories

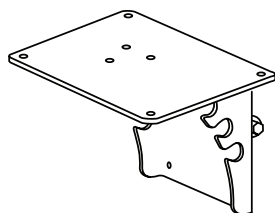

4A-VESA-PMO
Patient monitor bracket for Philips and Nihon Kohden bottom mounts, 4FVB-1 required

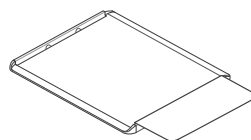

4A-SHF-48
Shelf extension set, 8" per side for endoscopy scope

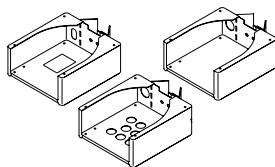

4A-FPH-17
4A-FPH-22
Foot pedal holder

4A-HSKV-17
Skyvac holder

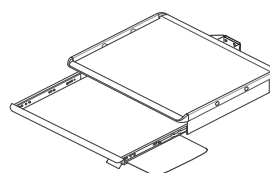

4A-PUS-22
22" Pullout write shelf

4A-PUK-22
22" Pullout keyboard tray with L/R mouse holder

4A-SUH-17
4A-SUH-22
Supply holder

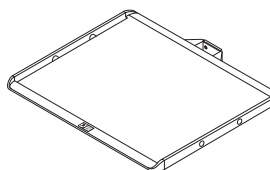

4A-SHC-17
17" Column shelf
4A-SHC-22
22" Column shelf
4A-SHC-32
32" Column shelf

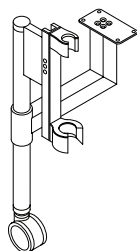

4A-SDOB
Streamline docking bracket

4A-SHC-39
39" Column shelf

Channel Mounted Accessories

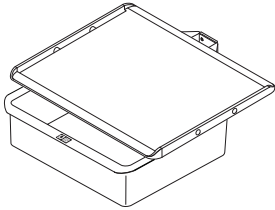

4A-BD-1-22-C

Single budget column drawer
Requires shelf

4A-BD-2-22-C

Double budget column drawer
Requires shelf

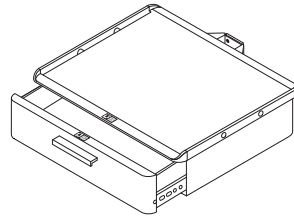

4A-PD-17-17

17" Premium drawer with 17" shelf

4A-PD-22-22

22" Premium drawer with 22" shelf

4A-PD-22-32

22" Premium drawer with 32" shelf

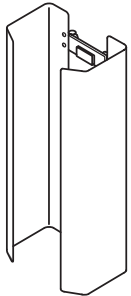

4A-BCC-37

Back cover for
4VBC-37/4CMC-37 only

4A-BCC-49

Back cover for
4VBC-49/4CMC-49 only

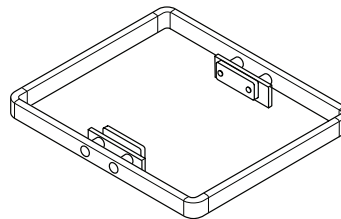

4A-ERW-W

Wraparound equipment rail for
wide column

4A-ERW-C

Wraparound equipment rail for
compact column

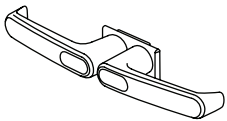

4A-HAC

Handle, column connection

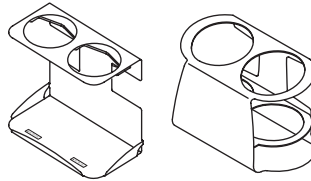

4A-BHCO

CO₂ bottle holder for two "E" cylinders

4A-BHUA

Universal bottle holder, adjustable

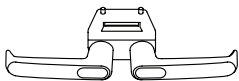

4A-HAS

Handle, shelf connection

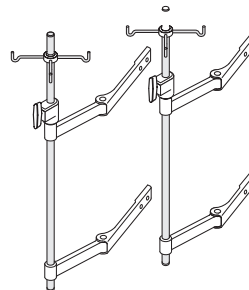

4A-IVE-C

Extendable wing bar for
compact carriers, with IV hooks

4A-IVE-W

Extendable wing bar for
wide carriers, with IV hooks

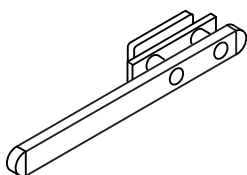

4A-ERCA-9

9" Equipment rail for
Skytrack, offset

4A-ERSB-13

13" Equipment rail for side
bar inside mount (T-nut)

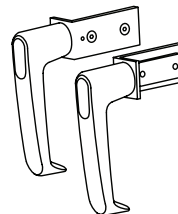

4A-HAB

Handle, sidebar connection

4A-ERCA-13

13" Equipment rail for
Skytrack, offset

Channel Mounted Accessories

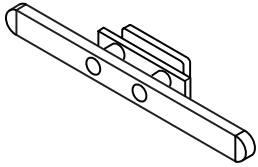

4A-ERCS-10

10" Equipment rail for Skytrack, centered

4A-ERCS-15

15" Equipment rail for Skytrack, centered

4A-ERCS-20

20" Equipment rail for Skytrack, centered

4A-ERCS-30

30" Equipment rail for Skytrack, centered

4A-ERSH-17

17" Equipment rail for front of shelf

4A-ERSH-32

32" Equipment rail for front of shelf

4A-ERSH-22

22" Equipment rail for front of shelf

Smoke-E-Vac Accessories

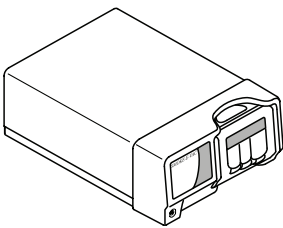

SMOKE-E-VAC

Smoke evacuation system requires mounting bracket

AIR SAFE

Filter for Smoke-e-vac system, 35 hour 2 pack

QUIKLINK

Automatic activation device for Smoke-e-vac

4A-HSKV-17

Mounting bracket for Smoke-e-vac system, mounts to shelf track

GCX Support Solutions

Please refer to the Model ID booklet for list of current monitor arms, patient monitor solutions, and keyboard mounts.

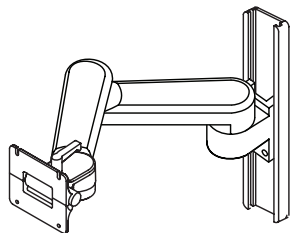

Monitor Mount

Flat-screen monitor mounts
Patient monitor mounts

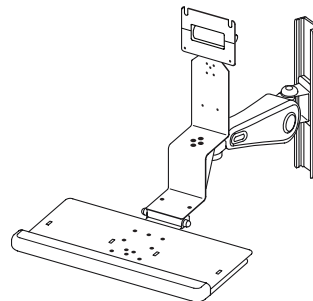

Multi-Purpose Mount

Monitor / keyboard mounts
Keyboard mounts

Horizontal Box Accessories

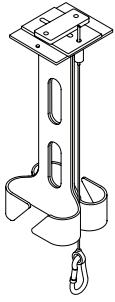

4A-CA-UB

Cable organizer
4UBW
4UBC

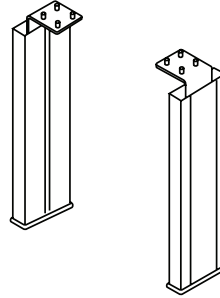

4A-EXU-12

12" Box extension

4A-EXU-24

24" Box extension for 17" and 22" box shelves

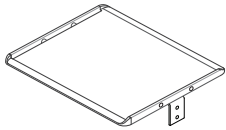

4A-SHB-17

17" Box shelf

4A-SHB-22

22" Box shelf

12" or 22" extension required

4A-SHT-17

17" shelf above box

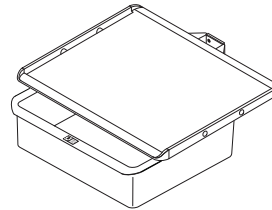

4A-BD-1-22-B

Single budget box drawer

4A-BD-2-22-B

Double budget box drawer

Display Accessories

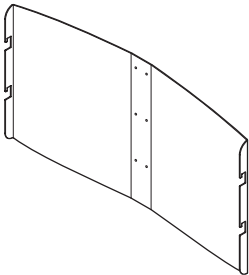

All require 4FXS-XX frame

4A-FXS-BC72

72" Large display frame back covers

4A-FXS-BC66

66" Large display frame back covers

4A-FXS-BC60

60" Large display frame back covers

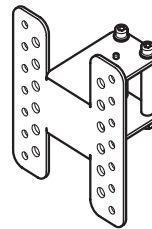

4A-BUD

Back up display mounts (set of 2), requires 4A-PFXX or 4FXS-XX

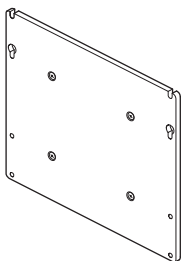

4A-VESA

VESA adapter plate, includes
100x100, 100x200, 200x200

Skytron's Solutions



Sterile Processing

Processing Sinks and Stainless Offerings
Washers, Ultrasonics, and Cart Washers
Prep & Pack Tables & Sterilizers



Clinical

Surgical Tables
Booms & Lights
Full Offering of Stainless Products



Architectural & Environmental

Modular Walls
Configurable Window and Door Offerings
Built-in Cabinetry



Clinical Business Intelligence

Video Integration
Asset Tracking & Supply Chain Solutions
Surgical Displays

Skytron provides safe and efficient healthcare solutions delivered through a local representative network that values long-term relationships and comprehensive service.

Focused on providing the highest quality solutions while delivering the lowest cost of ownership, we prioritize transparency and accountability in our actions

To learn more, visit our website at www.skytron.com



5085 Corporate Exchange Blvd. SE
Grand Rapids, MI 49512
1.800.SKYTRON (759-8766)
email: info@skytron.com
www.skytron.com



REV5 06-25
PN L2-010-206